

Specifications:

Axial Sensitivity (20±5°C)	10 mV/g
Measurement Range (Peak Value)	500 g
Transverse Sensitivity	≤ 5%
Frequency Response (±5%)	1~10000 Hz
Mounting Resonance Frequency	40000 Hz
Temperature Response	Refer to Temp. Curve
Polarity	Positive
Power Supply Voltage (Constant Current Source)	+12~+24 VDC
Operation Current	+2~+10 mA
Max. Output Signal (Peak Value)	6V
Noise (1Hz~20kHz)	<0.5 mg
Output Impedance	<100 Ω
DC Bias Voltage	7±1 VDC
Operation Temp. Range	-40~+120 °C
Shock Limit	3000g
Temperature Coefficient	10mg/°C(0.3Hz)
Magnetic Sensitivity	1.5g/T
Base Strain Sensitivity	0.2mg/με
Weight	11g
Case Material	Stainless Steel
Mounting Method	M5
Sensing Element	PZT-5
Sensing Geometry	Shear
Output Type	L5
Grounding	Signal Ground Connected to Case
M5 Stud, Protection Cap	Included
Low Noise Cable to BNC	Included
Calibration Certificate	Included

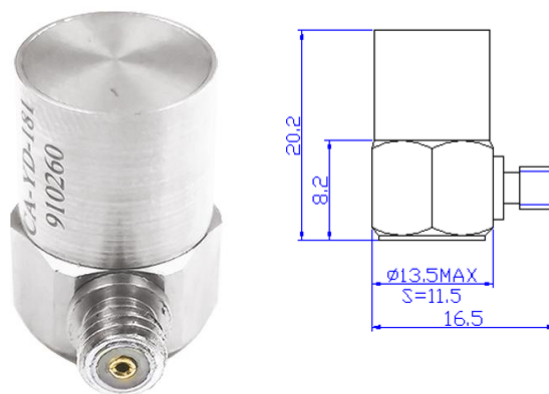

Schematic diagram

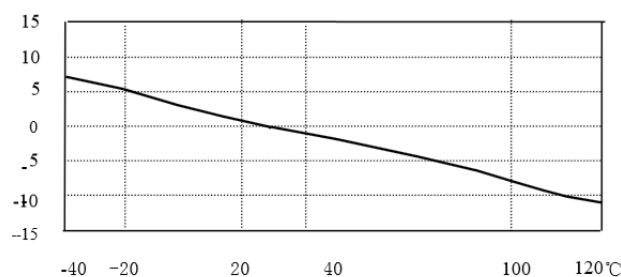

Typical Temperature Response Curve

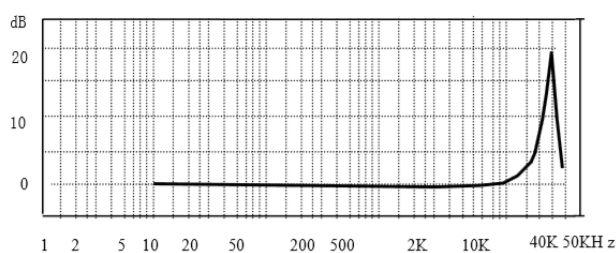

Typical Frequency Response Curve